

60000

Skinne 310 4.00m cc 1m

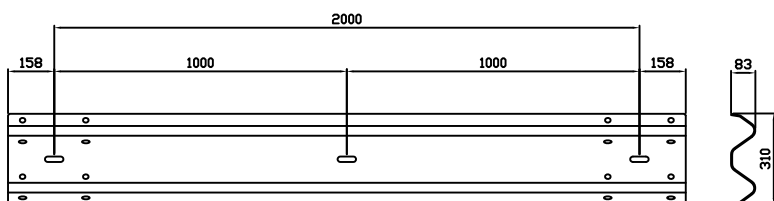

60005

Skinne 310 2,00m cc1m

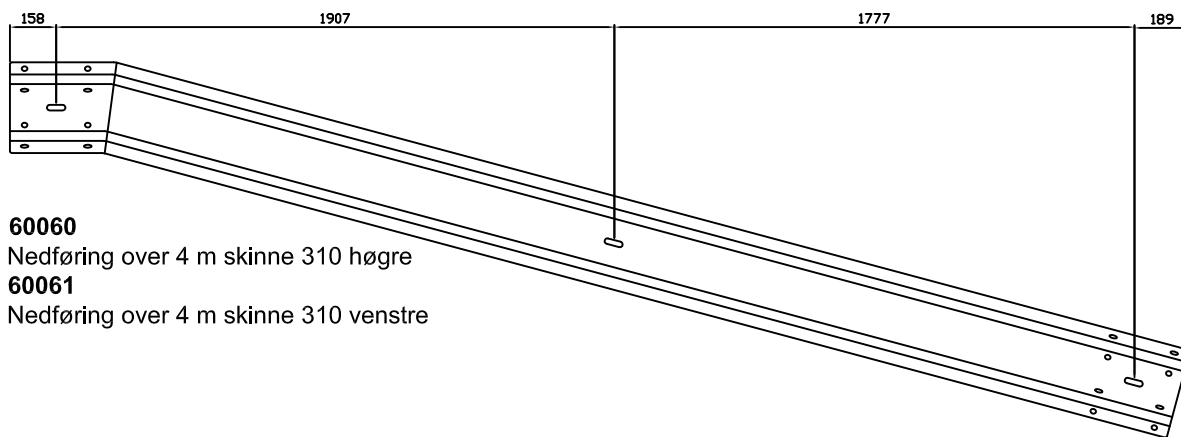

60060

Nedføring over 4 m skinne 310 høyre

60061

Nedføring over 4 m skinne 310 venstre

Vik:
6893 Vik i Sogn

Tlf: +47 57 69 86 50
Faks: +47 57 69 86 60
firmapost@vikorsta.no

Ørsta:
Skorgeura
6150 Ørsta

Tlf: +47 70 04 70 00
Faks: +47 70 04 70 04
firmapost@vikorsta.no

A-profil
Side 1

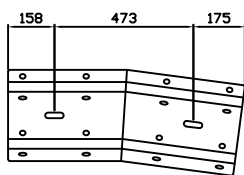

60055
Nedføring over 8 m
universal skinne 310

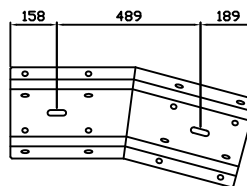

60050
Nedføring over 4 m
universal skinne 310

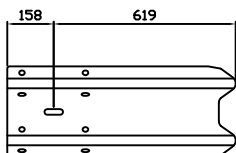

60100
Endestykke bøyd L=0,7 høyre
skinne 310

60101
Endestykke bøyd L=0,7 venstre
skinne 310

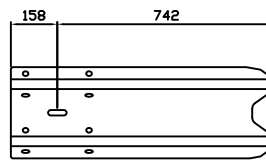

60104
Endestykke bøyd 90 L= 1m høyre
skinne 310

60105
Endestykke bøyd 90 L= 1m venstre
skinne 310

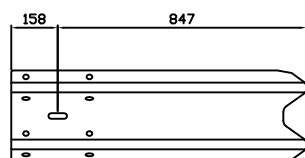
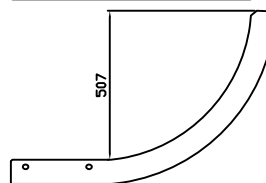
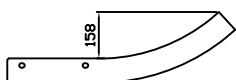

60102
Endestykke bøyd 90 L=1,3m

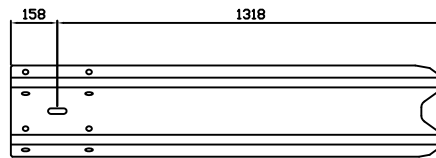

60106
Endestykke bøyd 90 L=2m

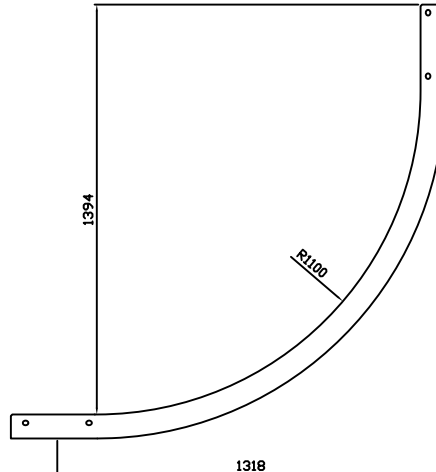
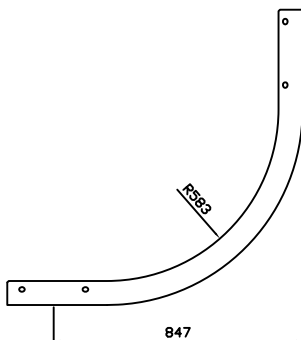

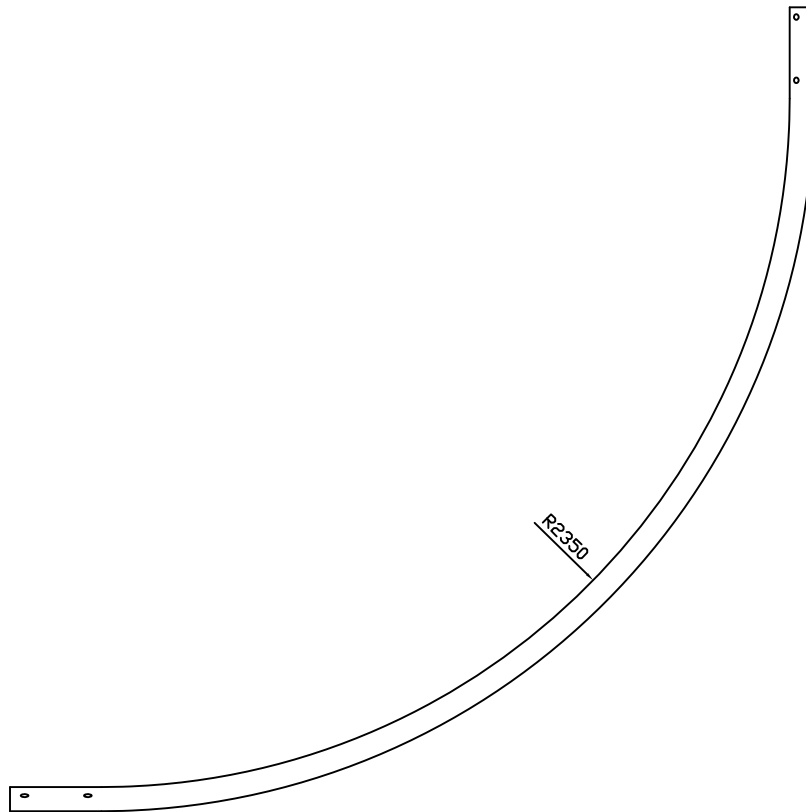
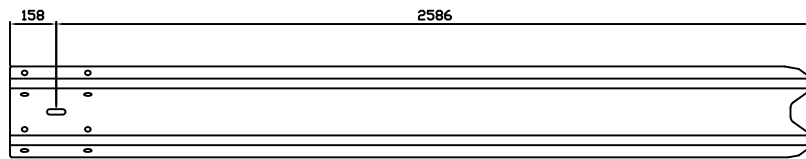

60108
Endestykke bøyd 90 L=4m

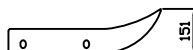
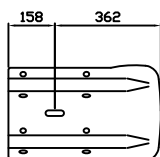

60110
Endestykke senkpressa 0,7m venstre

60112
Endestykke senkpressa 0,7 m høyre

Vik:
6893 Vik i Sogn

Tlf: +47 57 69 86 50
Faks: +47 57 69 86 60
firmapost@vikorsta.no

Ørsta:
Skorgeura
6150 Ørsta

Tlf: +47 70 04 70 00
Faks: +47 70 04 70 04
firmapost@vikorsta.no

A-profil
side 3

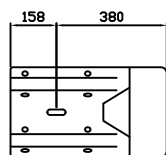

60121

Boksehanske 310 enkel høyre

60122

Boksehanske 310 enkel venstre

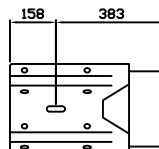
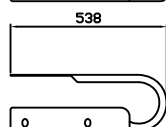

60120

Boksehanske 310 dobbel

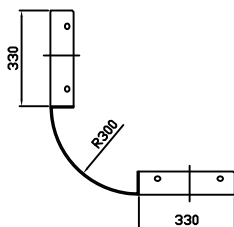
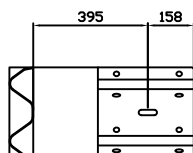
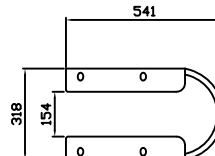

60141

Hjørne utvendig skinne
R=0,3m

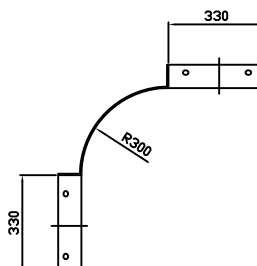
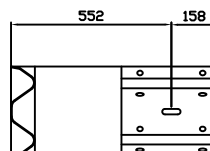

60140

Hjørne innvendig skinne 310
R=0,3m

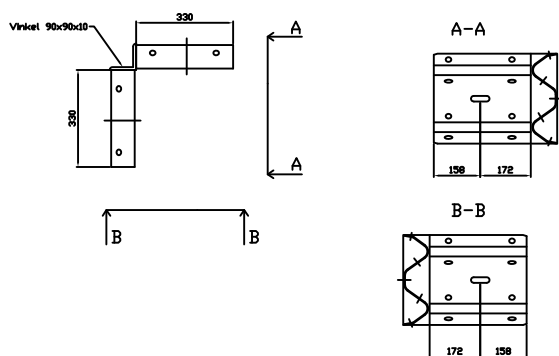

60142
Hjørne innv. 90 skinne 310

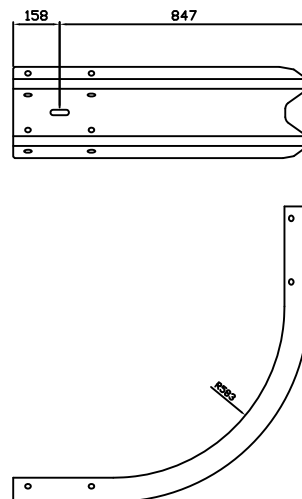

60143
Hjørne utv. 90 skinne 310 L=1,28 m

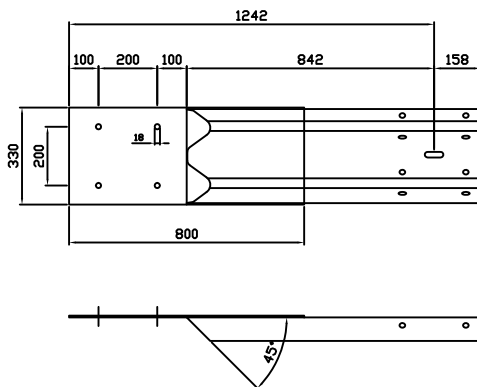

60151 Overgang fra skinne 310 til betong venstre
60150 Overgang fra skinne 310 til betong høyre

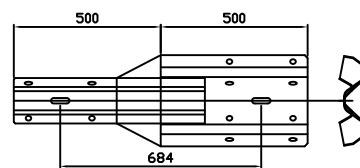

60159
Overg. skinne 310 til skinne 155

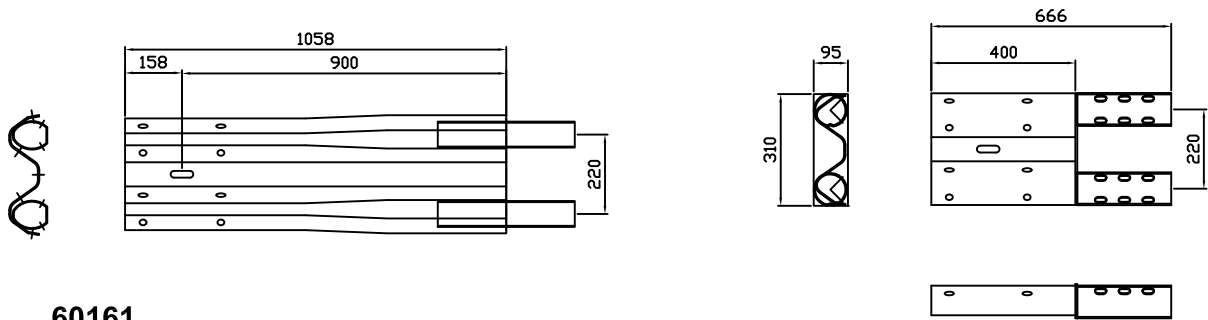

60161

Overg. Sicuro veg til skinne 310

60162

Overg. skinne 310 til Sicuro veg

60163

Overg. Sicuro bru til skinne 310

60164

Overg. skinne 310 til Sicuro bru

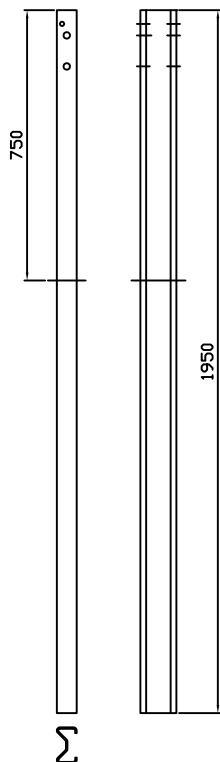

60200 Sigmastolp 4mm L= 1950

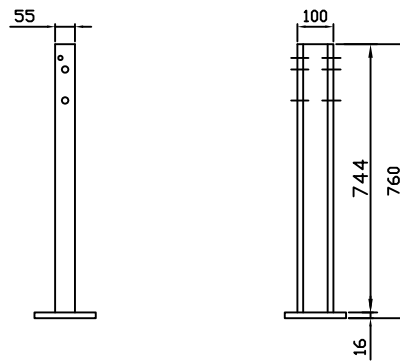

60228 Sigmastolp L=760 m/fotpl.
170x170x16

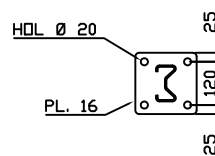

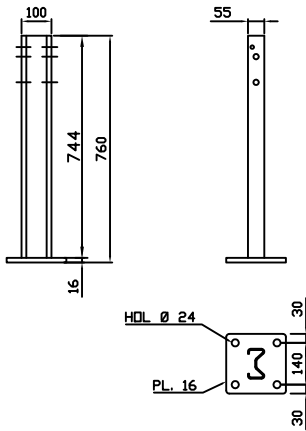

60230 Sigmastolp L=760 m/fotpl.
200x200x16

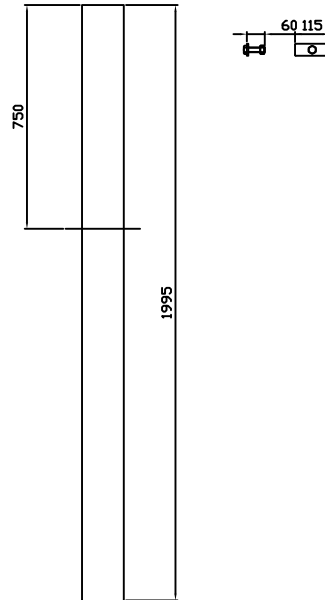

60244 Stolpe plast Ø140x14mm L=2m

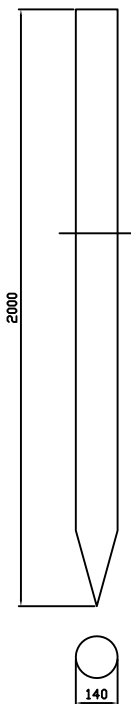

60240 Trestolp

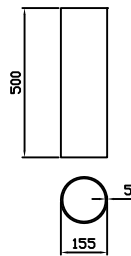

60242 Plasthylse for trestolp

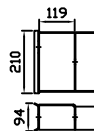

60251
Utblokningsbøyle for
trestolp

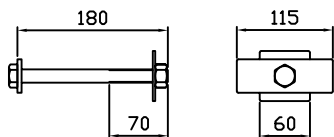

60601
Festesats for trestolp
M16x180

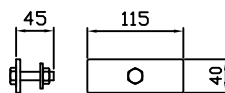

60607
Festesats for
Sigmastolp M10x45

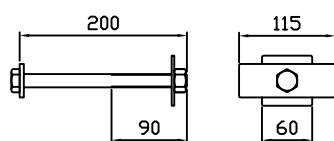

60602
Festesats for trestolp
m/plasthylse
M16x200

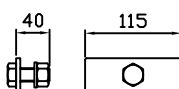

60610
Festesats for utblokningsbøyle til
sigmastolpe

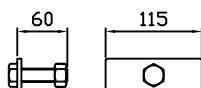

60604
Festesats for
plaststolpe
M16x60



60639
Skjøteskrue for
Skinne 310, M16x25
m/Flensmutter

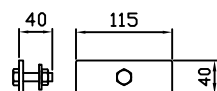

60606
Festesats for
Sigmastolp M10x40