

65000

Skinne 155 4.00m cc 2m

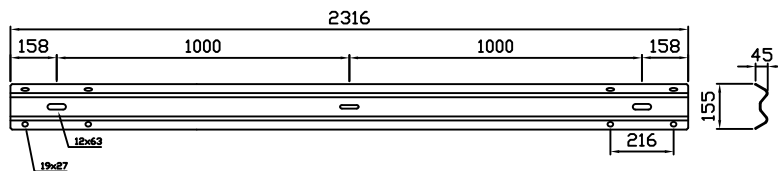

65005

Skinne 155 2,00m cc1m

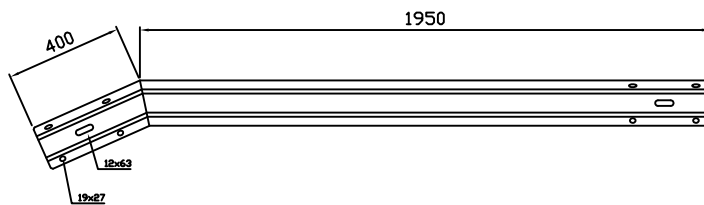

65020

Nedføring over 2 m skinne 155 høyre

65021

Nedføring over 2 m skinne 155 venstre

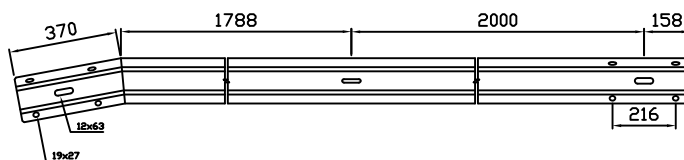

65030

Nedføring over 4 m skinne 155 høyre

65031

Nedføring over 4 m skinne 155 venstre

Vik:
6893 Vik i Sogn

Tlf: +47 57 69 86 50
Faks: +47 57 69 86 60
firmapost@vikorsta.no

Ørsta:
Skorgeura
6150 Ørsta

Tlf: +47 70 04 70 00
Faks: +47 70 04 70 04
firmapost@vikorsta.no

Lettprofil
Side 1

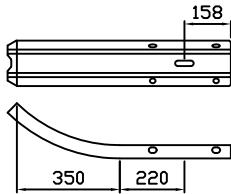

65040
Endestykke for skinne 155 bøyd 45, L=0,7m

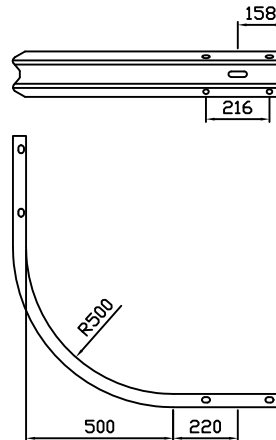

65045
Endestykke for skinne 155 bøyd 90, L=1,0m

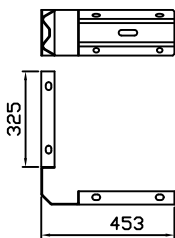

65050
Endestykke for skinne 155 utvendig hjørne

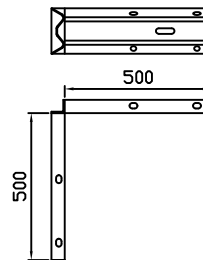

65051
Endestykke for skinne 155 innvendig hjørne

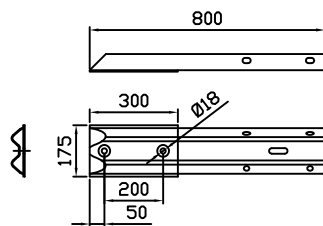

65053
Overgang for skinne 155 til betong

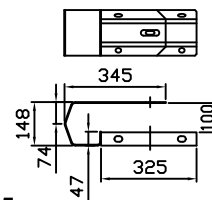

65055
Boksehanske for skinne 155, enkel

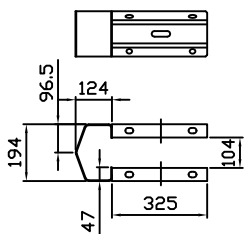

65056
Boksehanske for skinne 155, dobbel

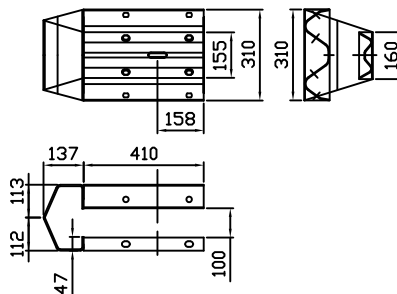

65057
Boksehanske for skinne 310/155

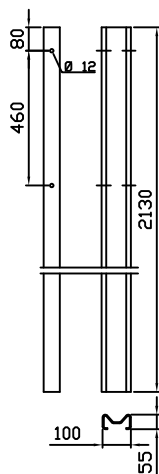

65200
Sigmastolpe 4 mm, L=2,13 m Ø12

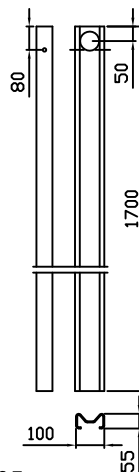

65205
Sigmastolpe 4 mm, L=1,7 m Ø12, endestolpe

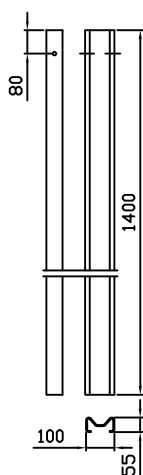

65210
Sigmastolpe 4 mm, L=1,4 m Ø12

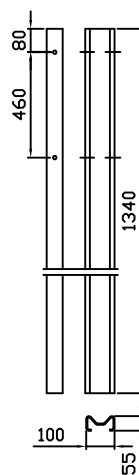

65215
Sigmastolpe 4 mm, L=1,34 m Ø12

Vik:
6893 Vik i Sogn

Tlf: +47 57 69 86 50
Faks: +47 57 69 86 60
firmapost@vikorsta.no

Ørsta:
Skorgeura
6150 Ørsta

Tlf: +47 70 04 70 00
Faks: +47 70 04 70 04
firmapost@vikorsta.no

Lett-profil
side 3

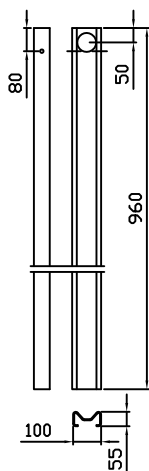

65220
Sigmastolpe 4 mm, L=0,96 m Ø12, endestolpe

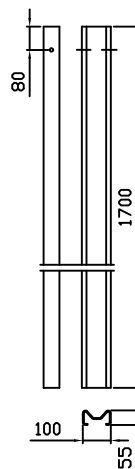

65235
Sigmastolpe 4 mm, L=1,7 m Ø12

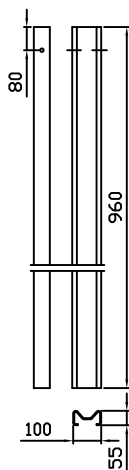

65245
Sigmastolpe 4 mm, L=0,96 m Ø12

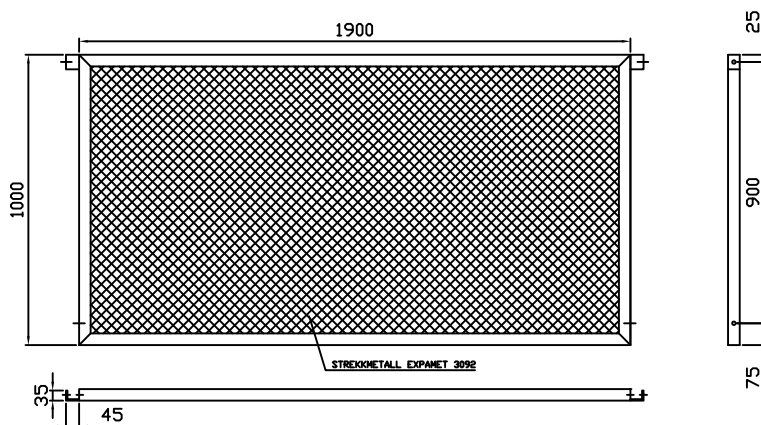

65290
Ramme med strekkmetall

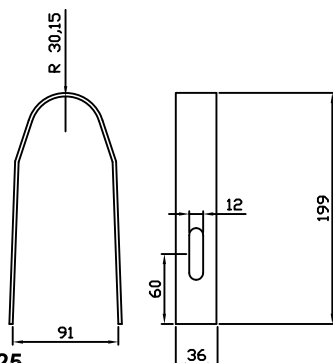

65325
Klammer for 2" for til Sigmastolpe

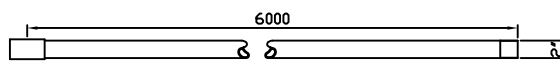

62600
Rør 2" Rett L=6m galv m/gjenger



65332
Festesats Mini W



60701
Festeskrue M10x30



65333
Skarvsats Mini W

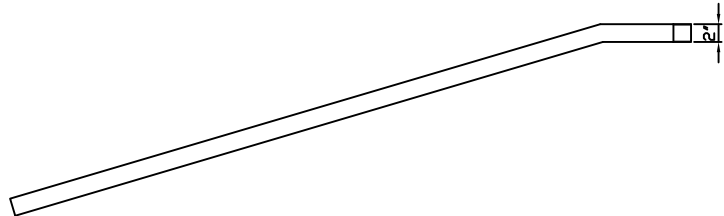

65310
Rør 2" Knekket L = 2,40m Lettrekkverk